



EXPLORE NEW PERSPECTIVES

Challenges for Surrogate Models in Real World Applications

Industrial Session – SAMCO Workshop

Enrico Rigoni

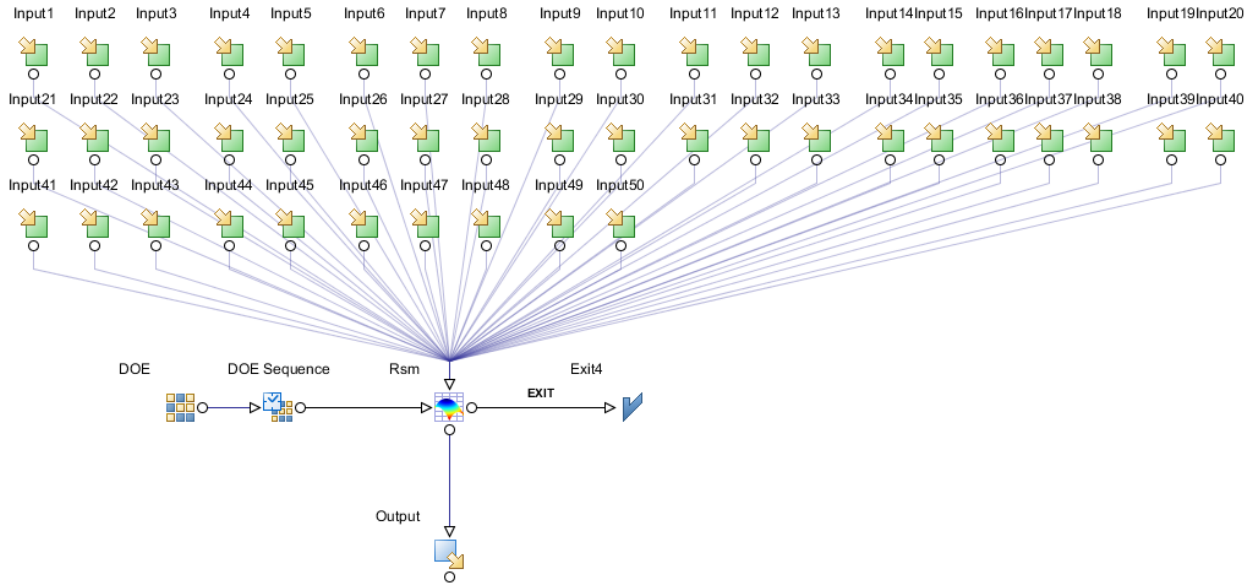

Smoothing Spline ANOVA

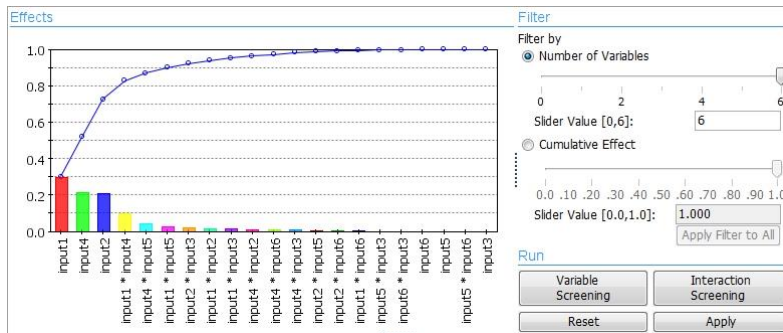

Stepwise Regression

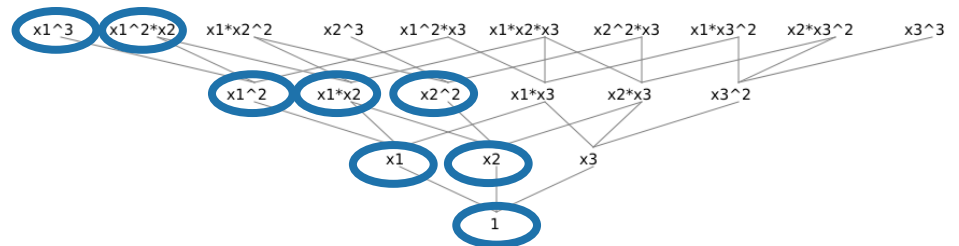

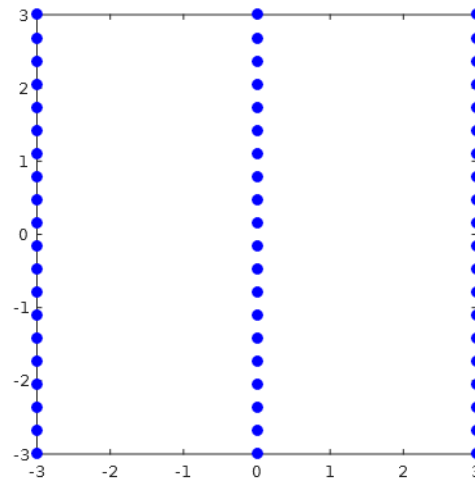
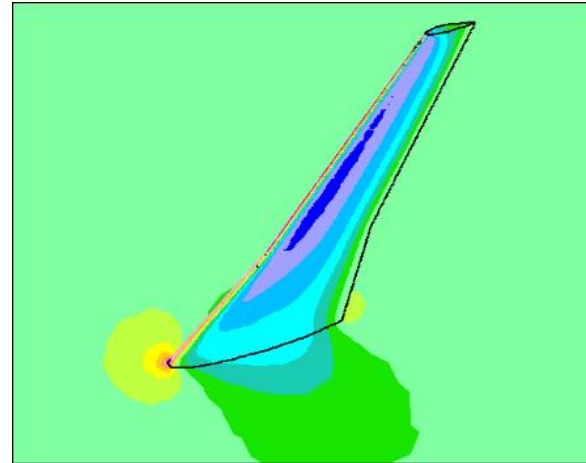
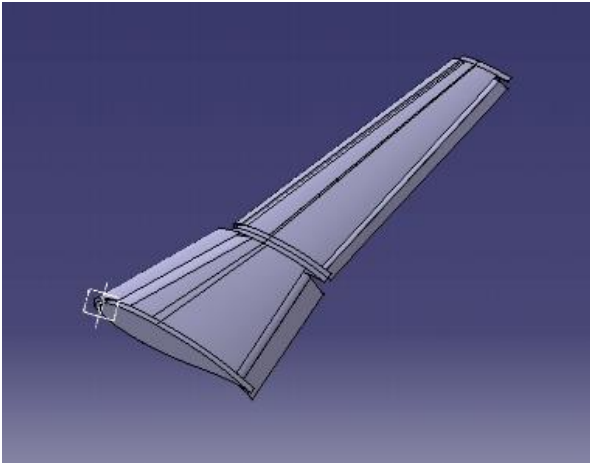

Anisotropic Kriging?

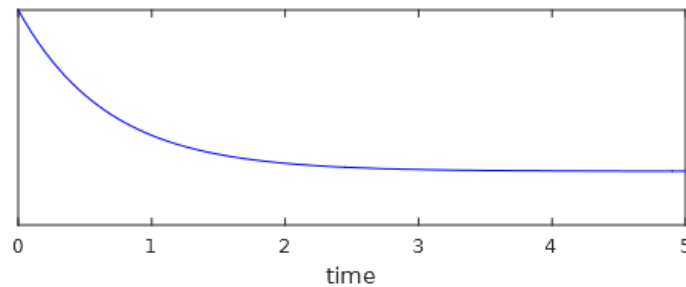
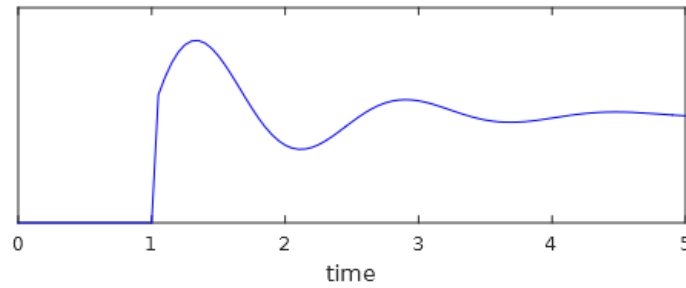
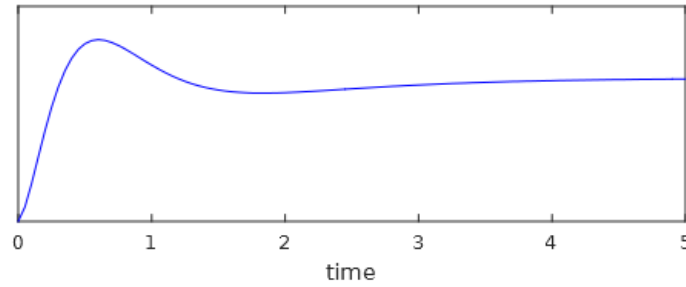
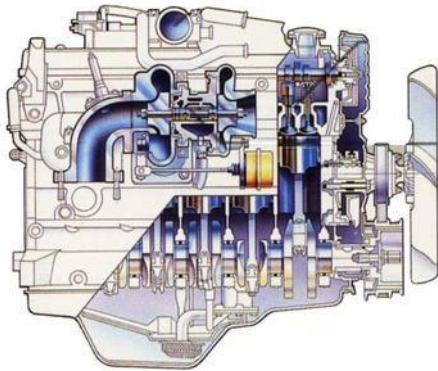

??